

Sæt X ved den høje blomst

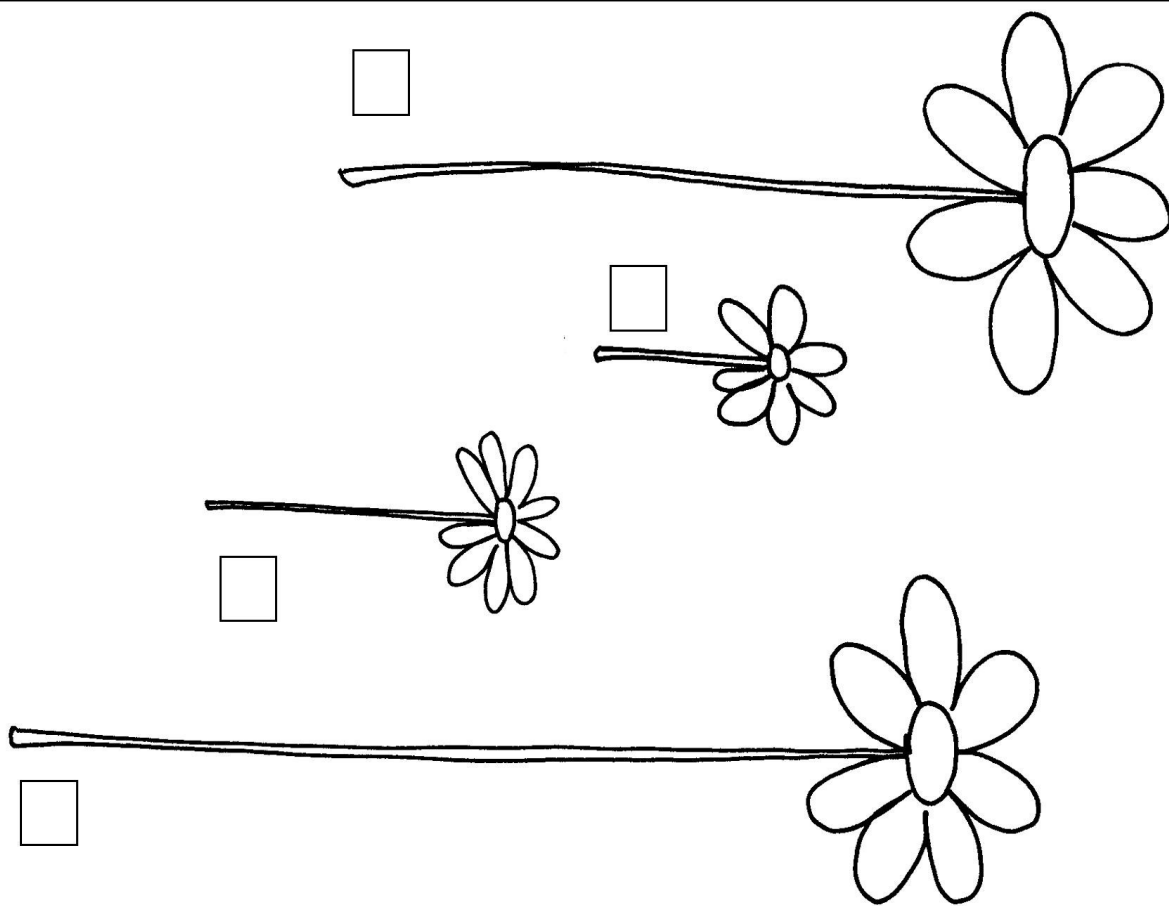

Sæt X ved den lave stige

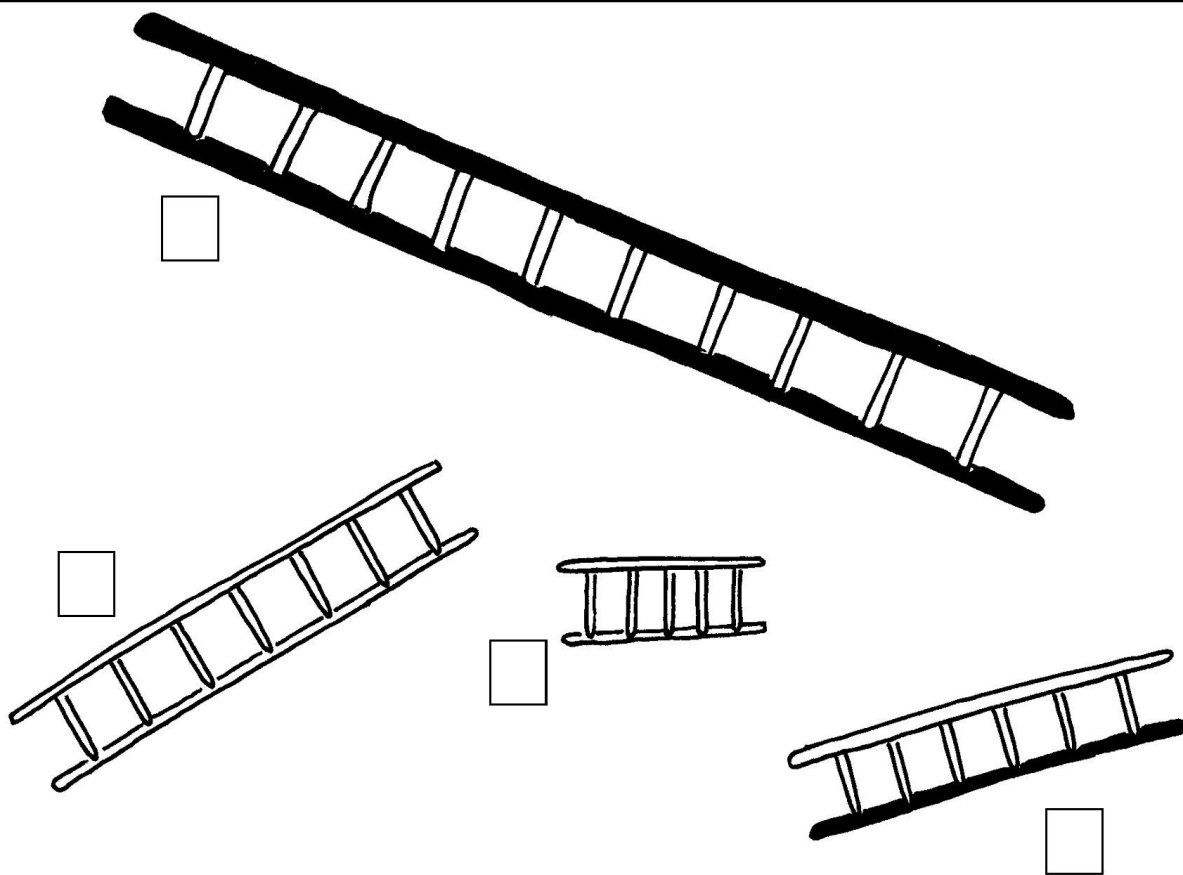

Sæt X ved den lange larve

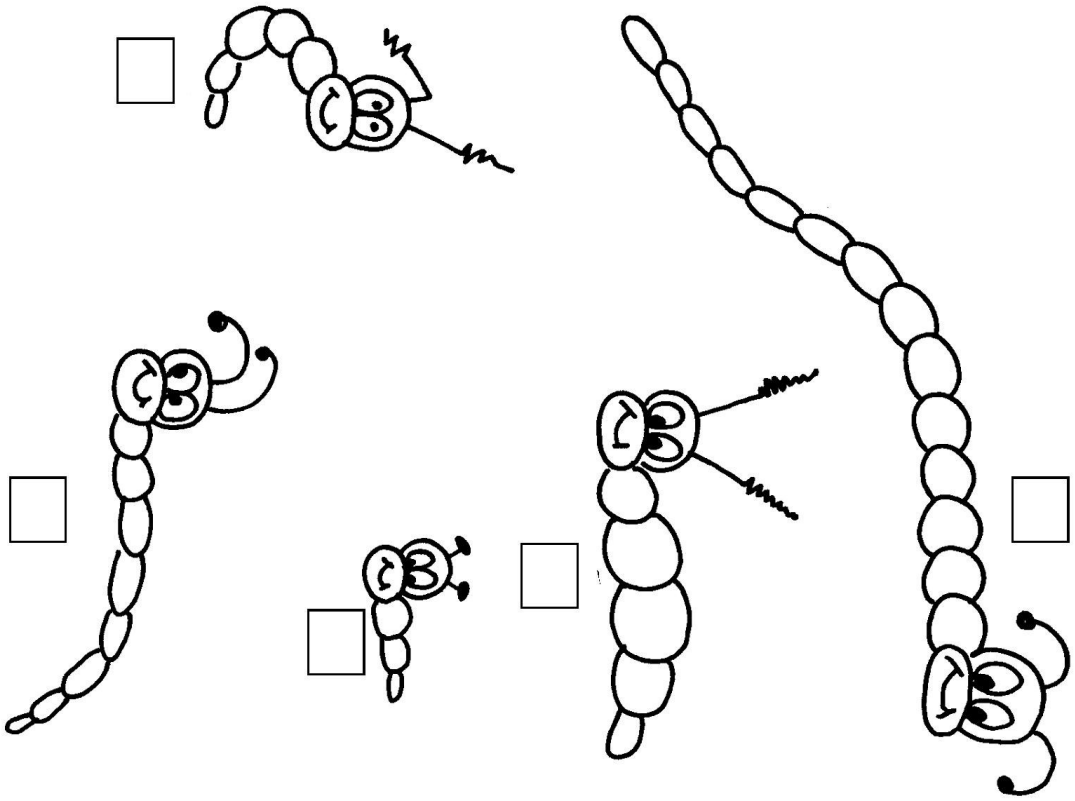

Sæt X ved den korte slikkestok

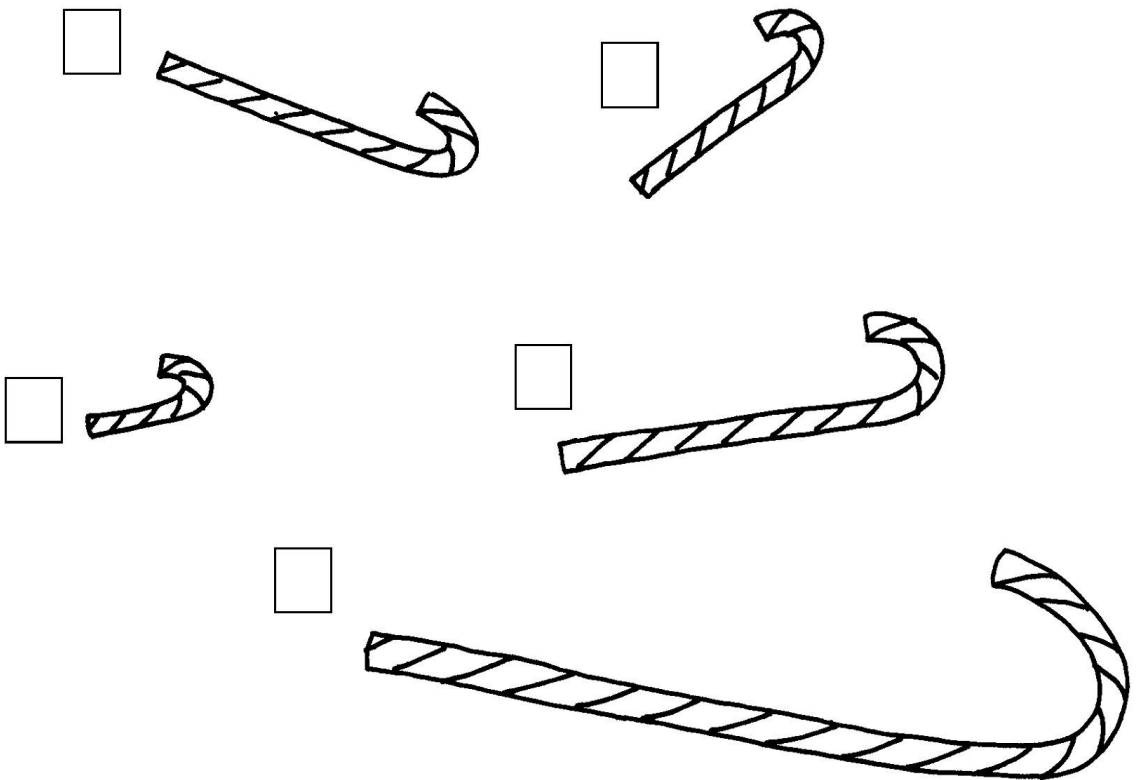

Sæt X ved det lange tog

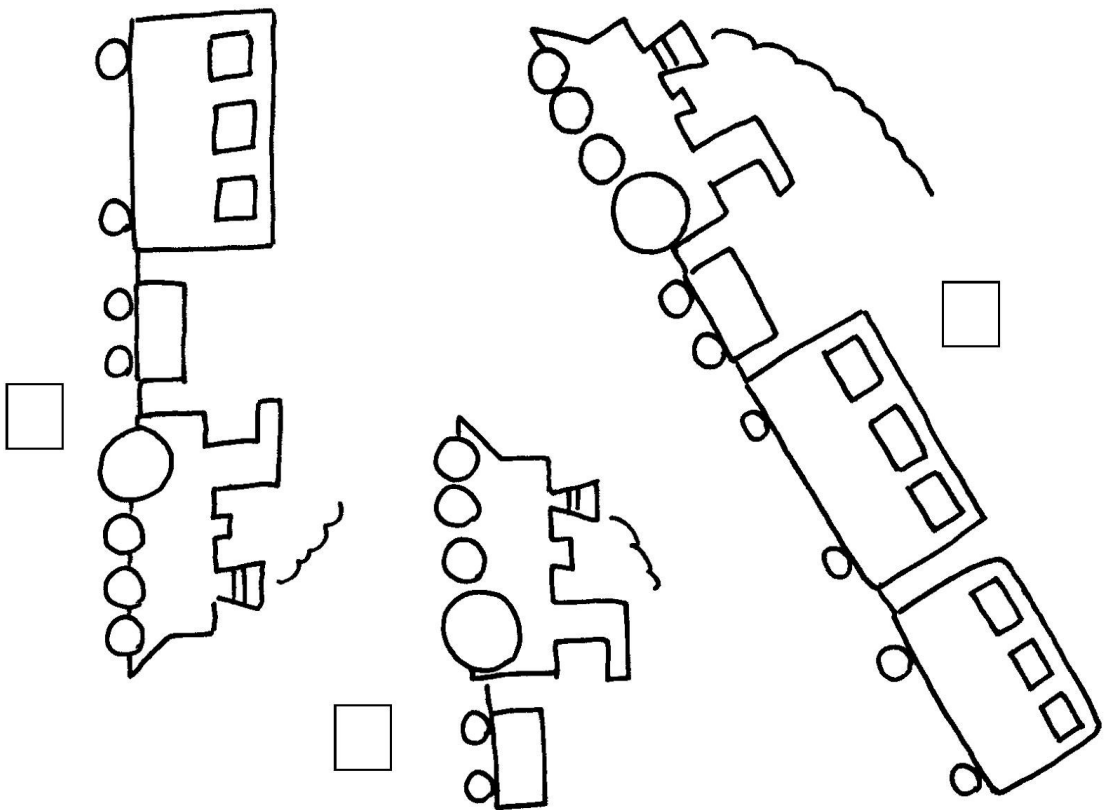

Sæt X ved den korte guleroed

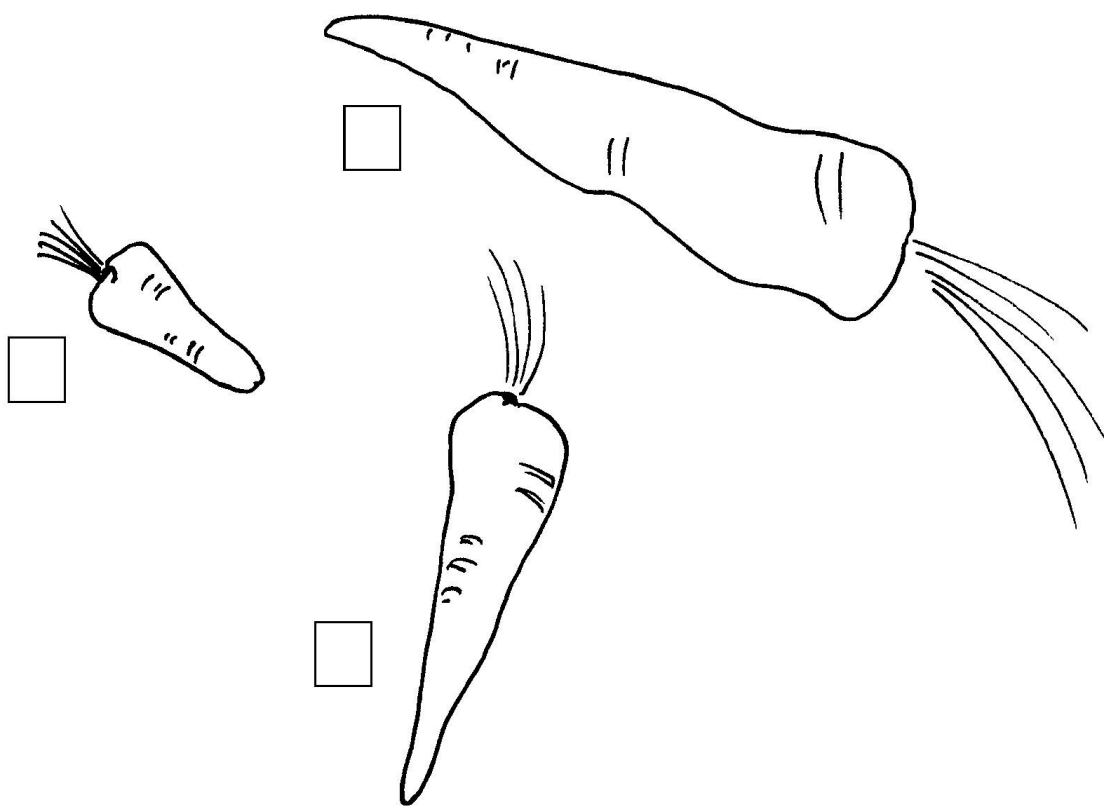

Sæt X ved den største is

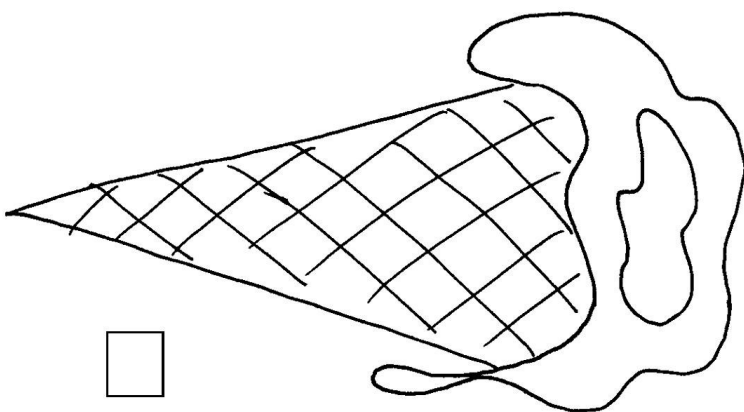
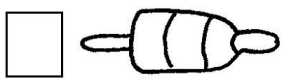

Sæt X ved den mindste kop

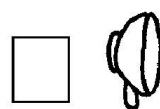
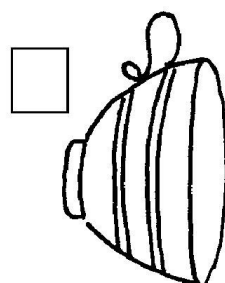
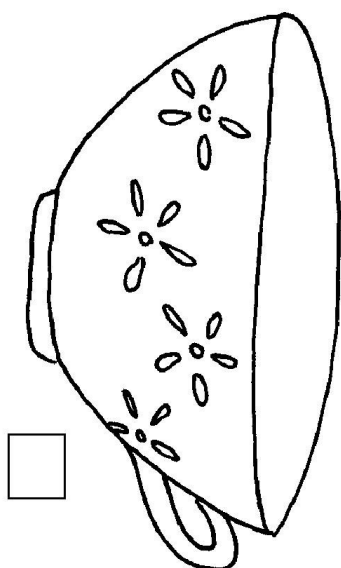
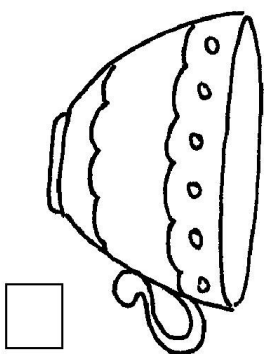

Sæt X ved den tynde blyant

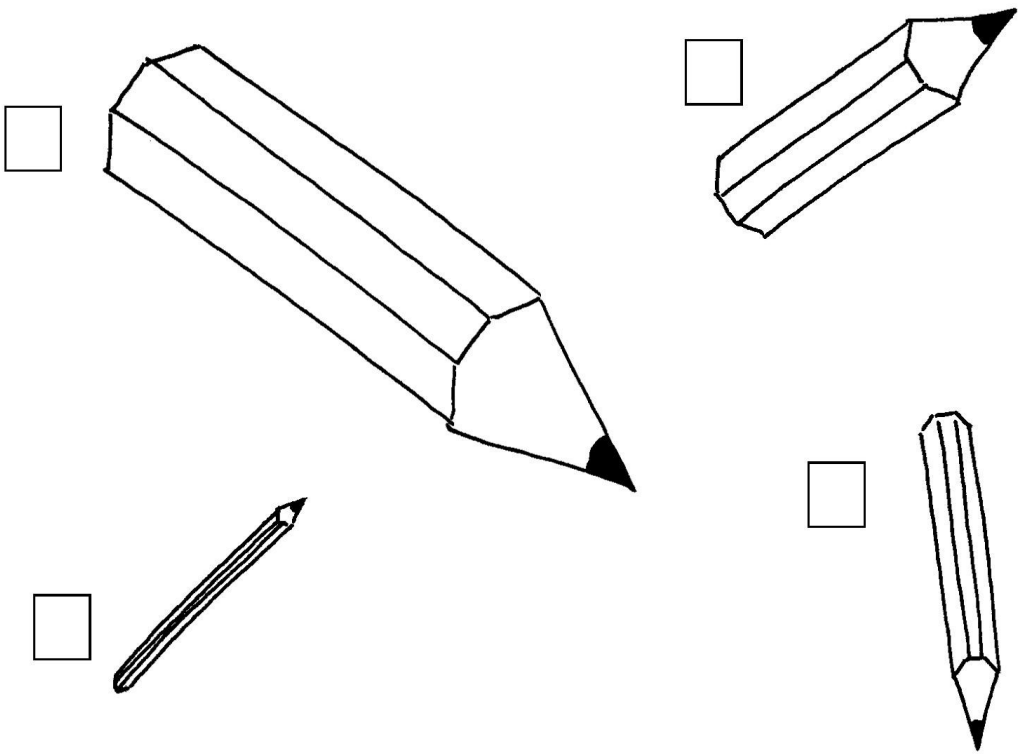

Sæt X ved den tykke pølse

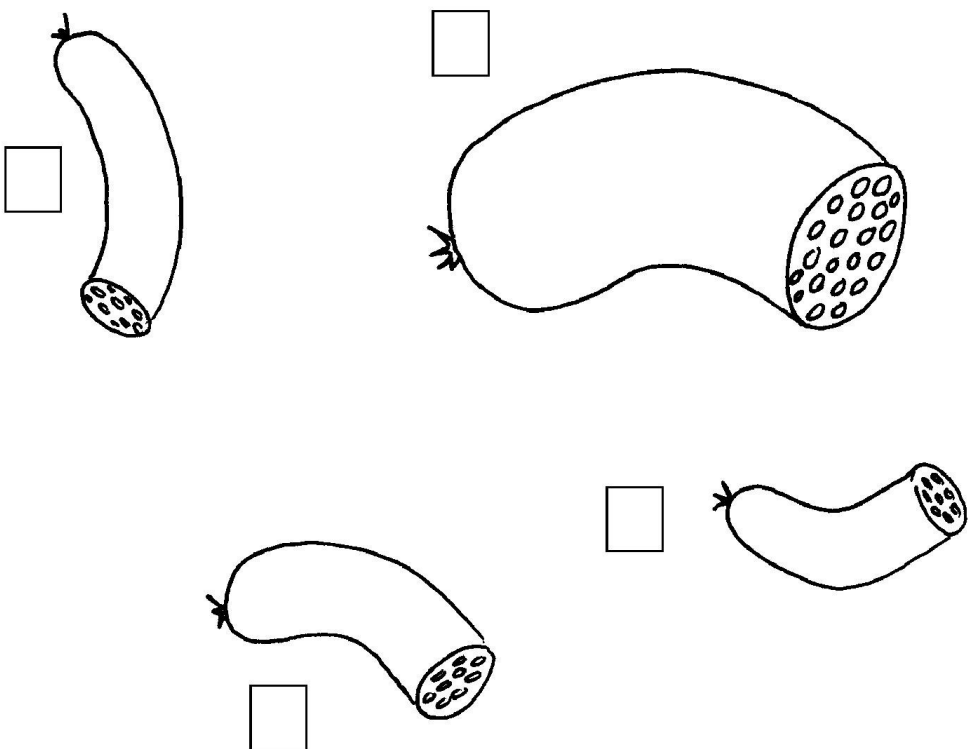

Sæt X ved den tynde ugle

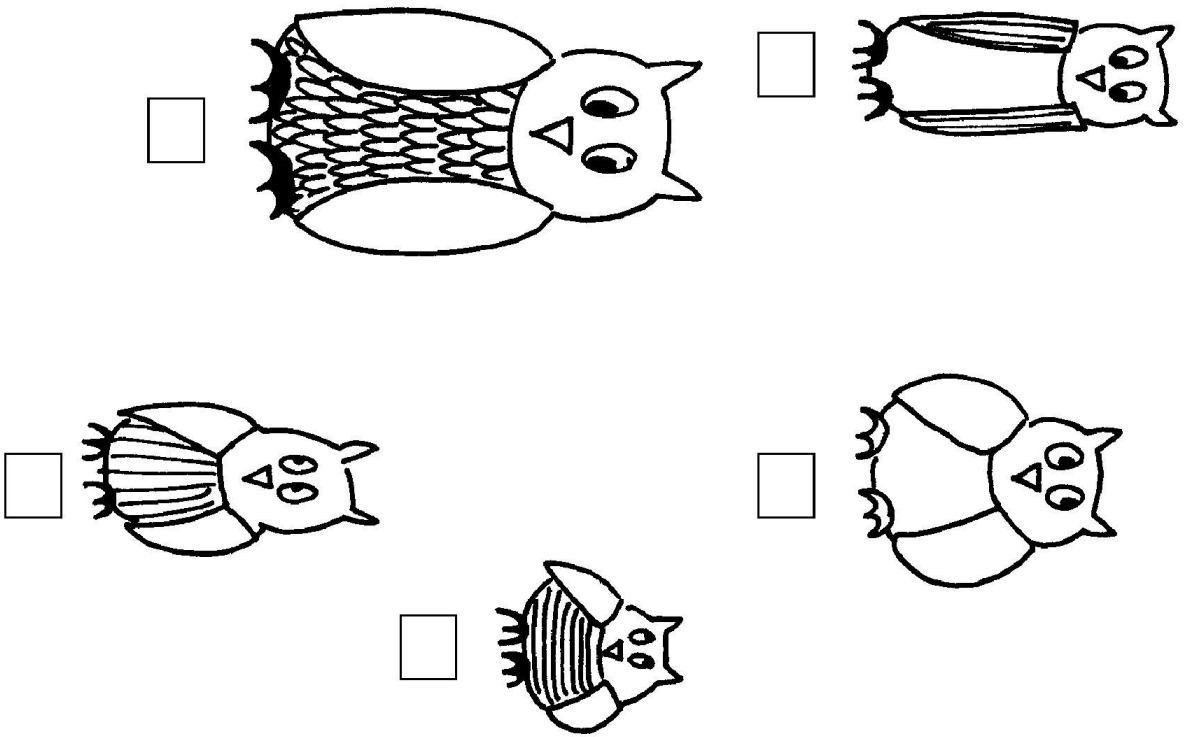

Sæt X ved den tykke bog

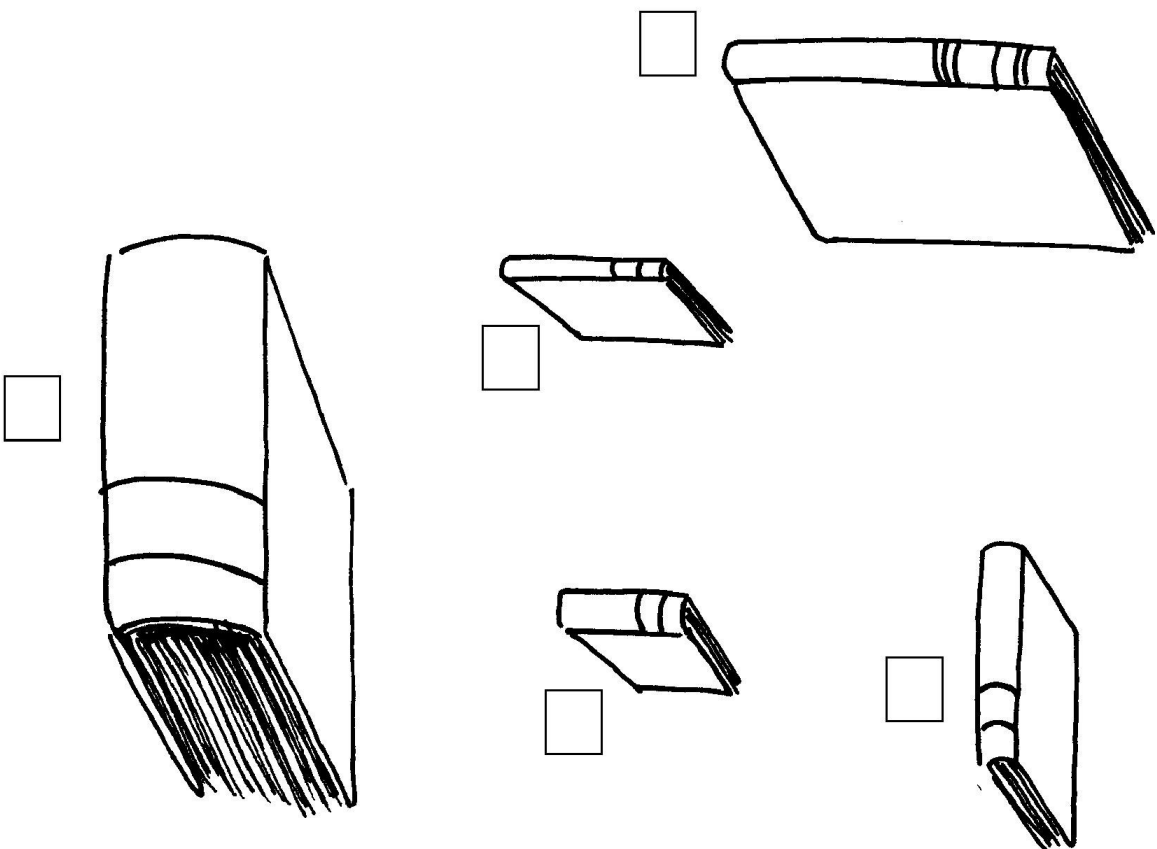

Sæt X ved den største kat

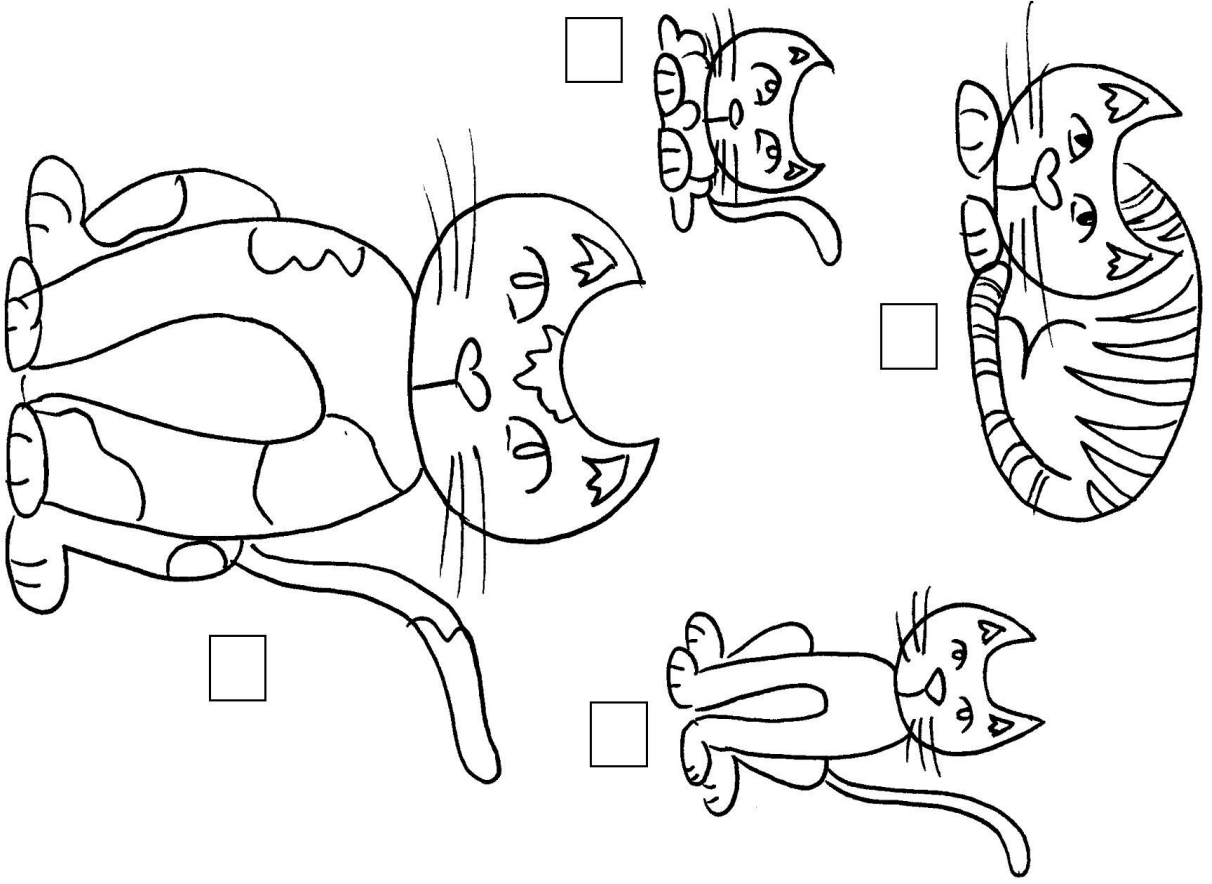

Sæt X ved den mindste fisk

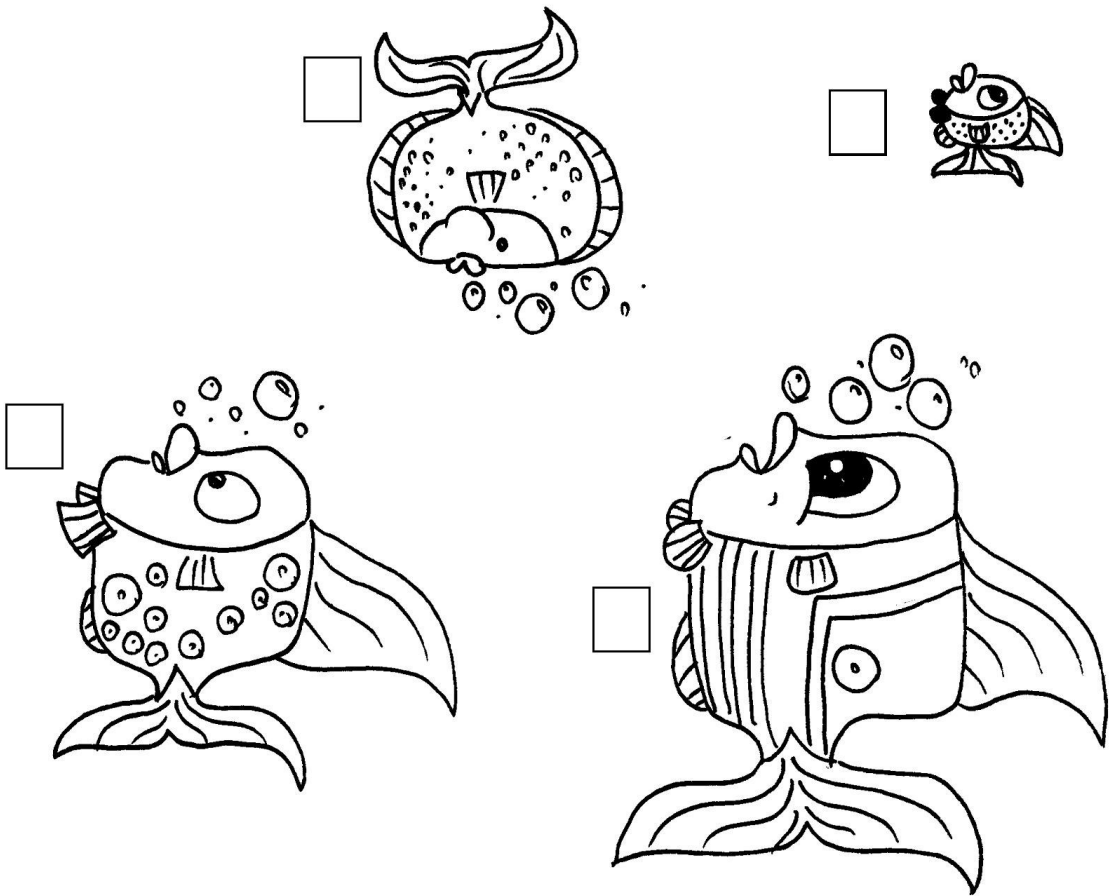

Sæt X ved den høje flagstang

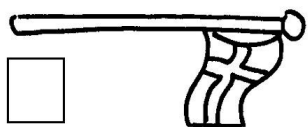
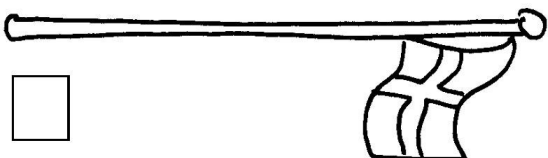
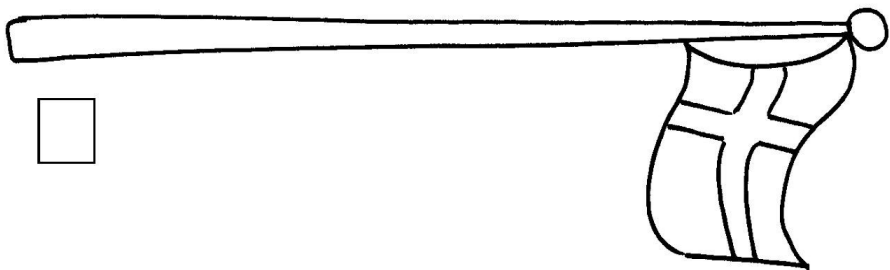

Sæt X ved det lave A

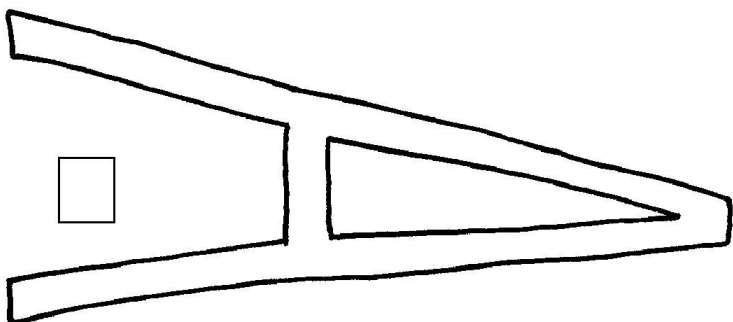
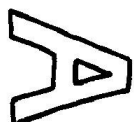
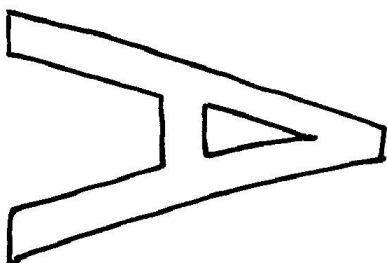
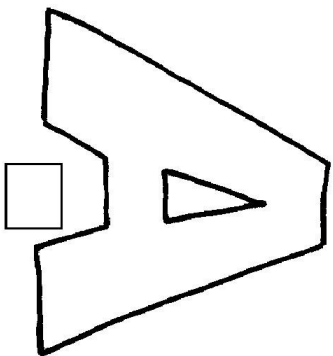



Sæt X ved den lange slange

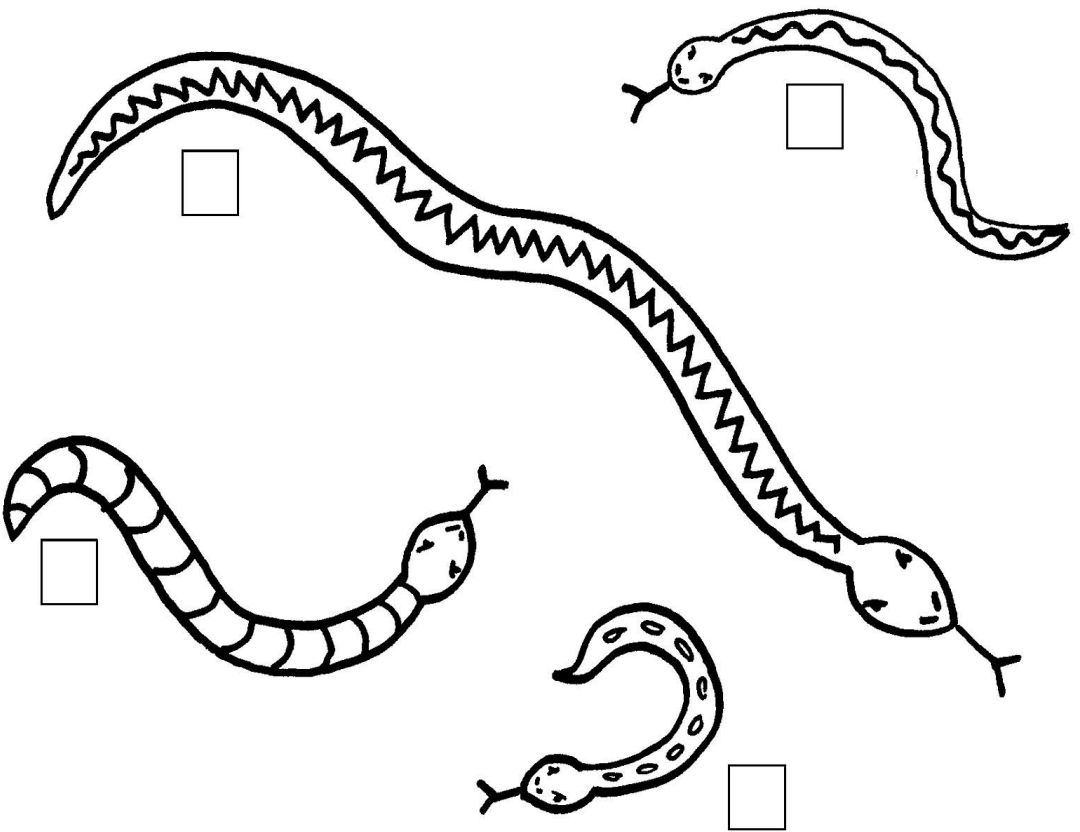

Sæt X ved det korte lys

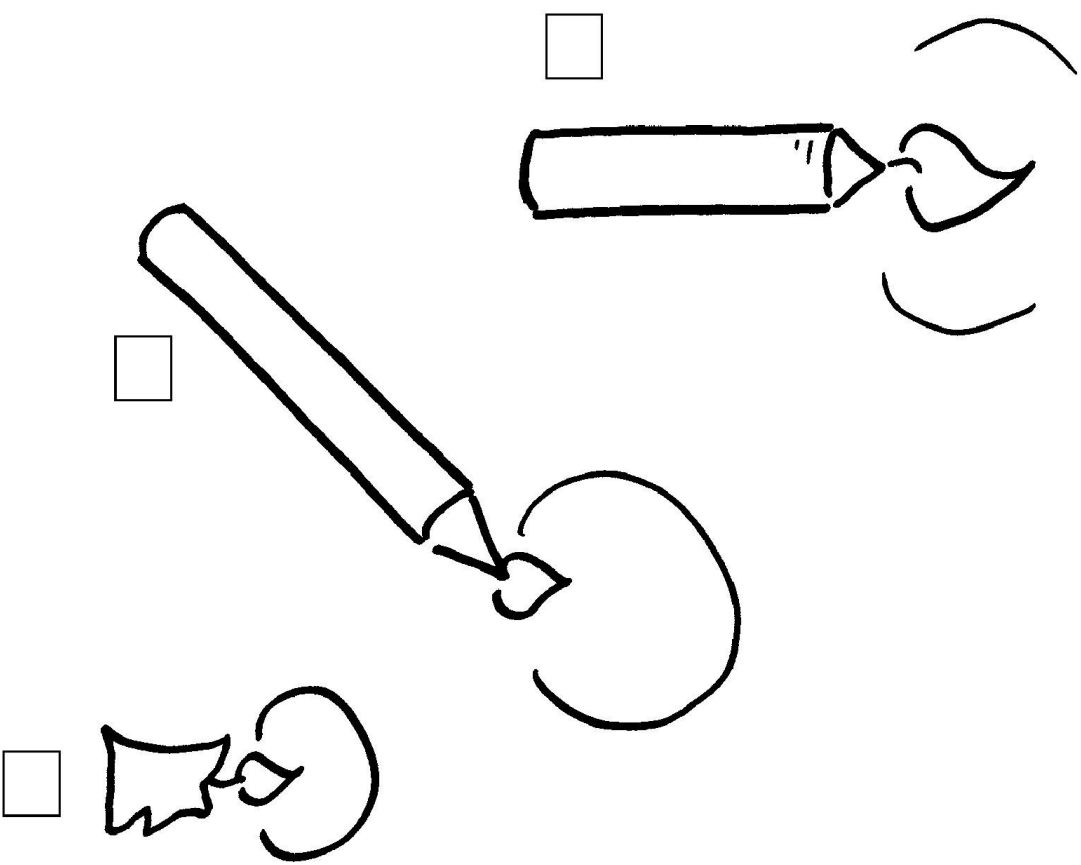

Sæt X ved det lange sværd

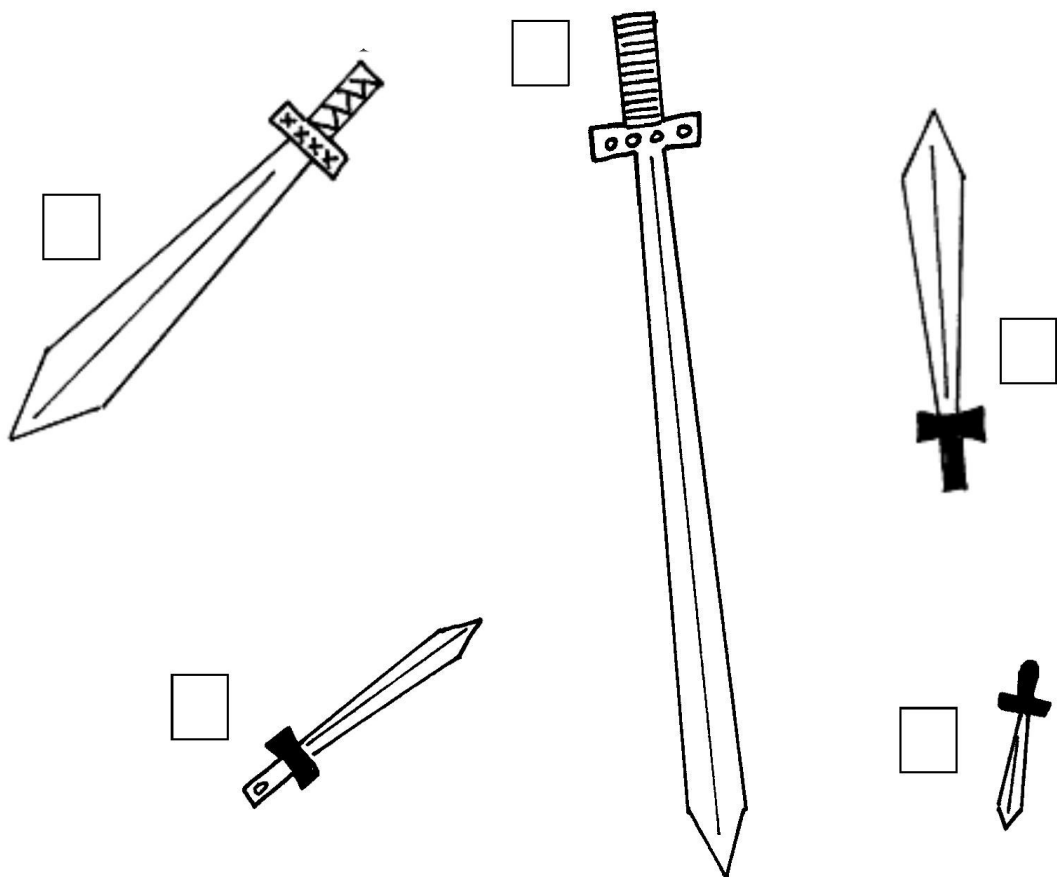

Sæt X ved den korte orm

