

Hvad koster sættet?

1

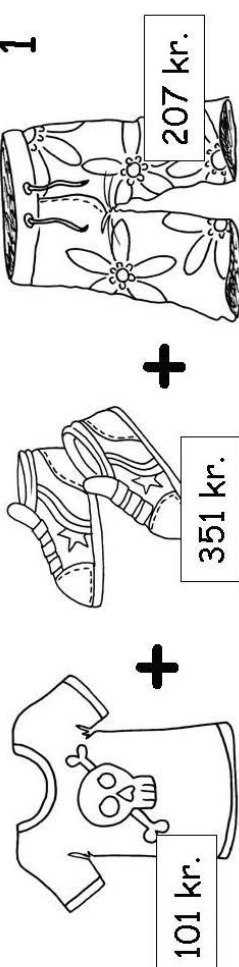

101 kr. + 351 kr. + 207 kr.

= \_\_\_\_\_ kr.

Hvad koster sættet?

3

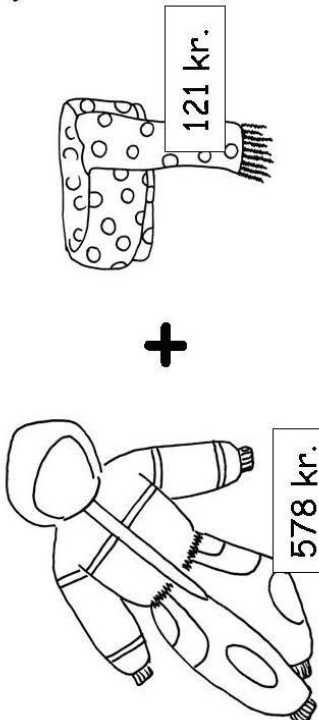

578 kr. + 121 kr.

= \_\_\_\_\_ kr.

Hvad koster sættet?

2

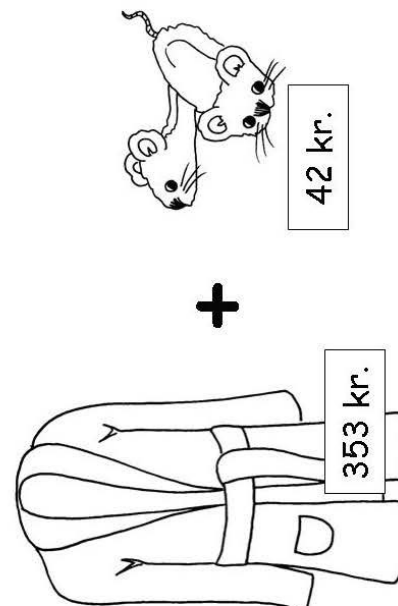

353 kr. + 42 kr.

= \_\_\_\_\_ kr.

Hvad koster sættet?

4

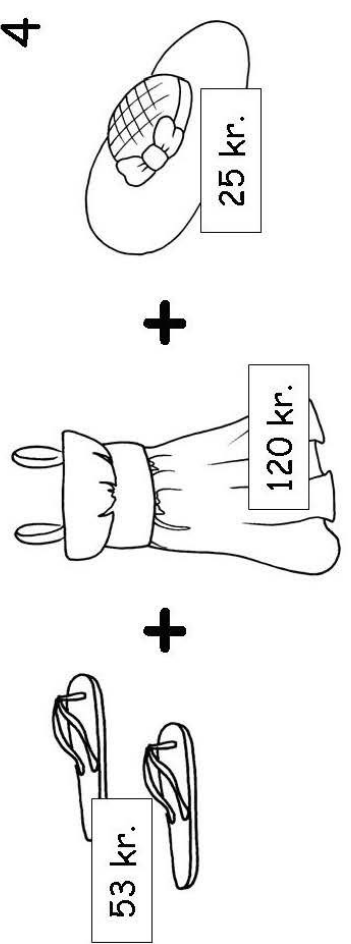

53 kr. + 120 kr. + 25 kr.

= \_\_\_\_\_ kr.

Hvad koster sættet?

5

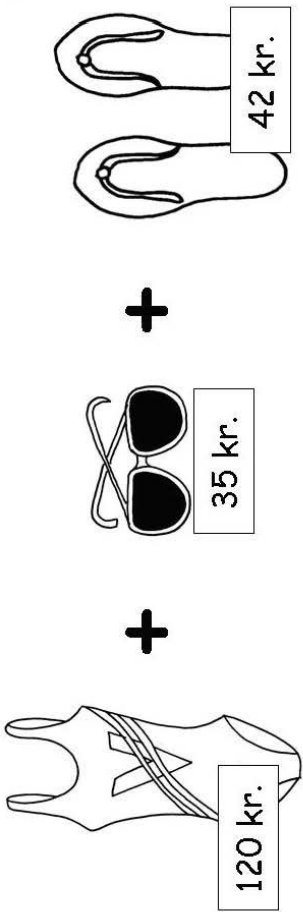

120 kr. + 35 kr. + 42 kr.

= \_\_\_\_\_ kr.

Hvad koster sættet?

7



50 kr. + 25 kr. + 112 kr.

= \_\_\_\_\_ kr.

Hvad koster sættet?

6

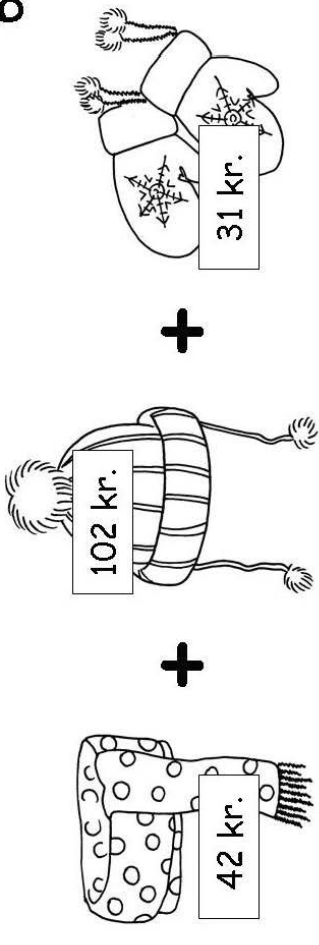

42 kr. + 102 kr. + 31 kr.

= \_\_\_\_\_ kr.

Hvad koster sættet?

8

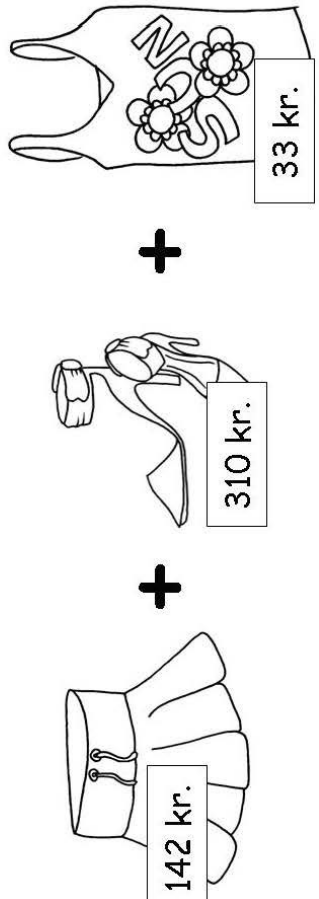

142 kr. + 310 kr. + 33 kr.

= \_\_\_\_\_ kr.

Hvad koster sættet?

9

401 kr. + 325 kr. + 142 kr.

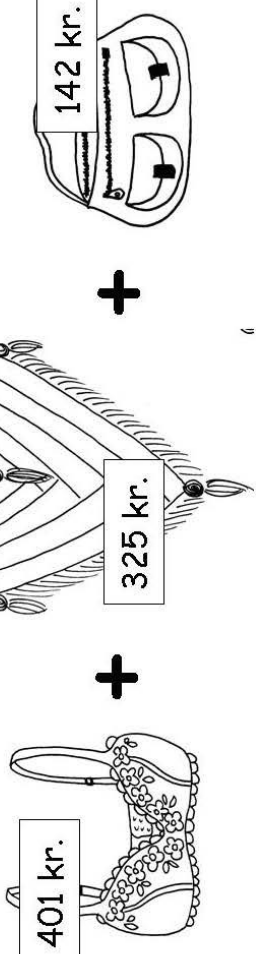

= \_\_\_\_\_ kr.

Hvad koster sættet?

11

437 kr. + 120 kr.

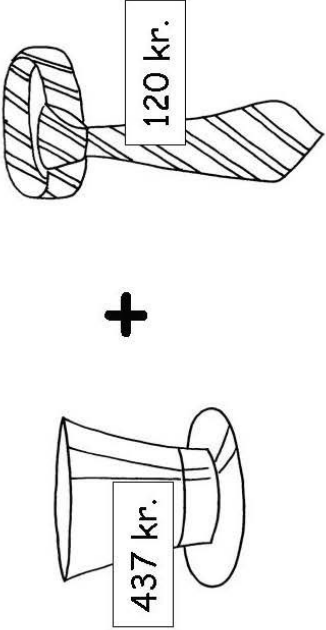

= \_\_\_\_\_ kr.

Hvad koster sættet?

10

242 kr. + 120 kr. + 30 kr.

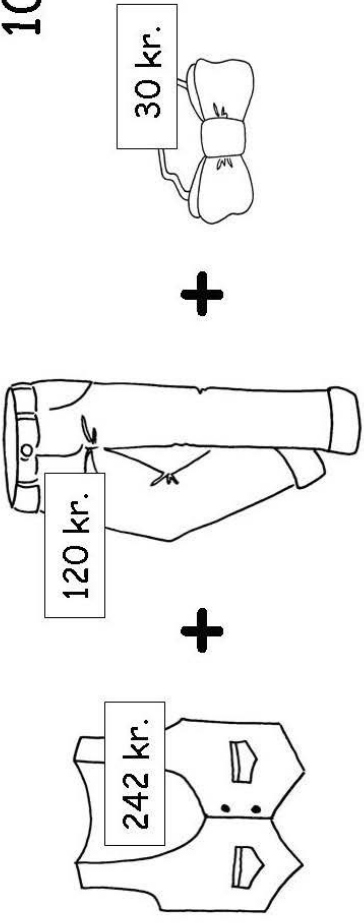

= \_\_\_\_\_ kr.

Hvad koster sættet?

12

113 kr. + 752 kr. + 131 kr.

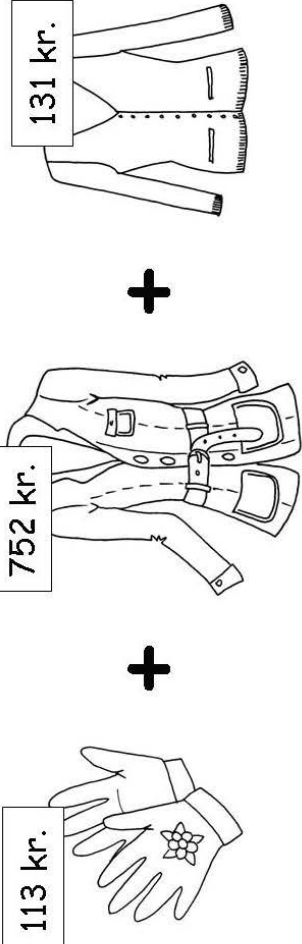

= \_\_\_\_\_ kr.

Hvad koster sættet?

13

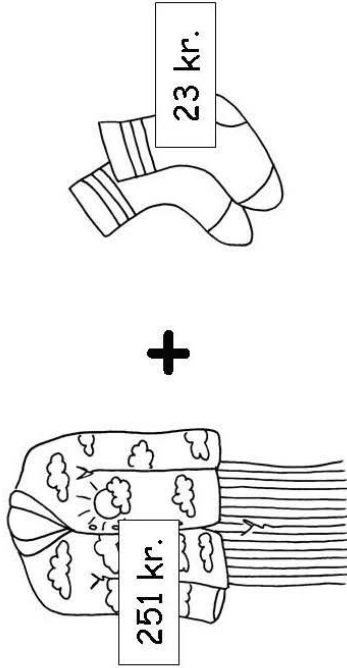

+

= \_\_\_\_\_ kr.

Hvad koster sættet?

15

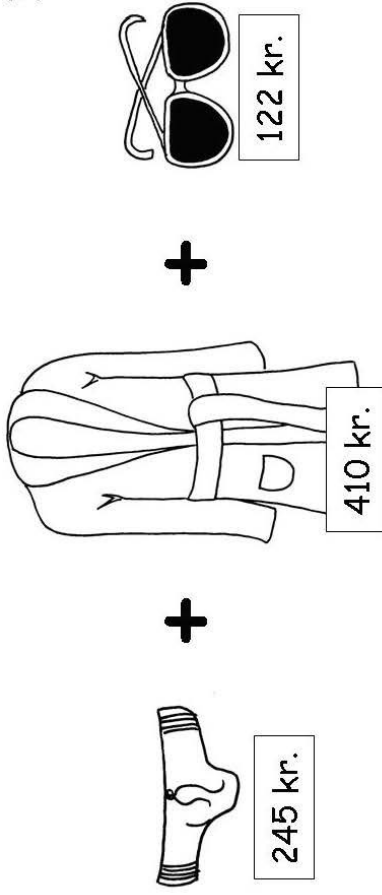

+

= \_\_\_\_\_ kr.

14

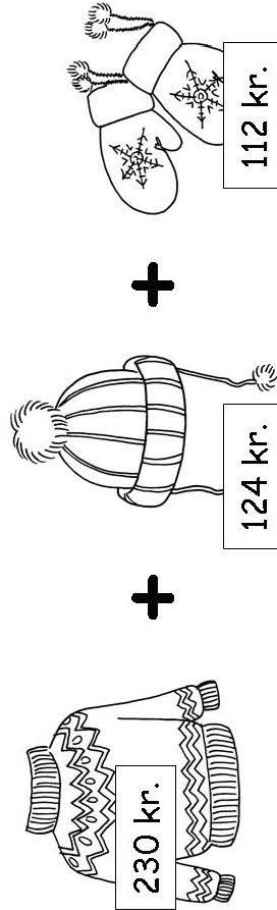

+

+

= \_\_\_\_\_ kr.

16

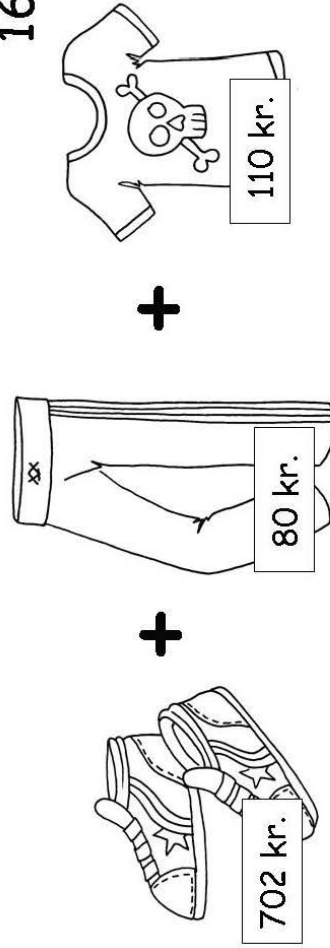

+

+

= \_\_\_\_\_ kr.

Hvad koster sættet?

17

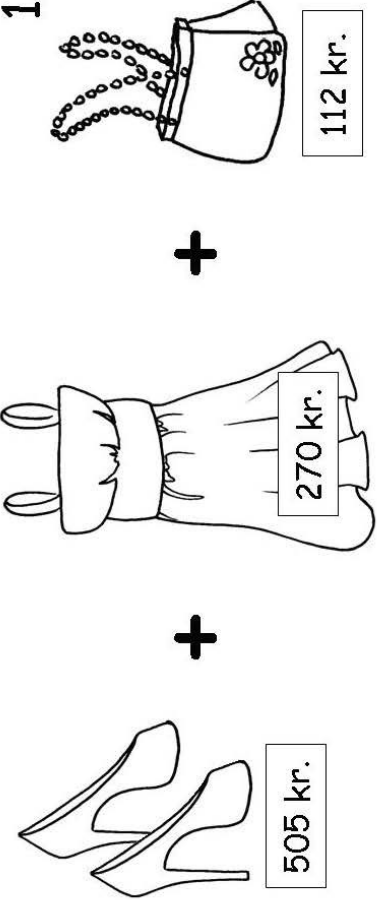

505 kr. + 270 kr. = \_\_\_\_\_ kr.

112 kr.

Hvad koster sættet?

19

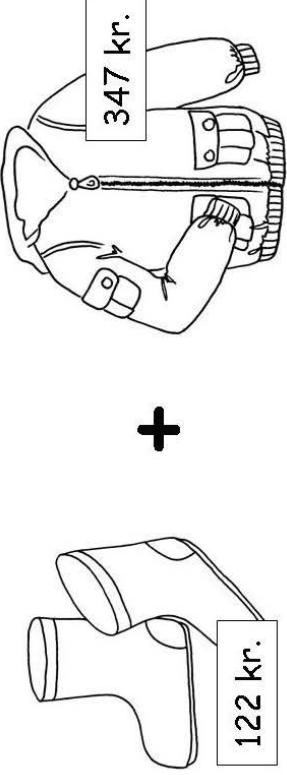

122 kr. + 347 kr. = \_\_\_\_\_ kr.

Hvad koster sættet?

18

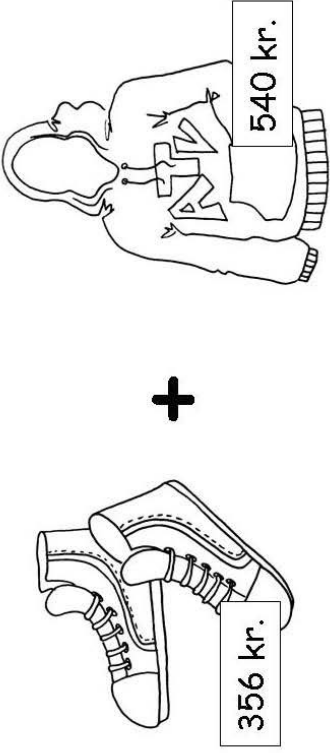

356 kr. + 540 kr. = \_\_\_\_\_ kr.

Hvad koster sættet?

20

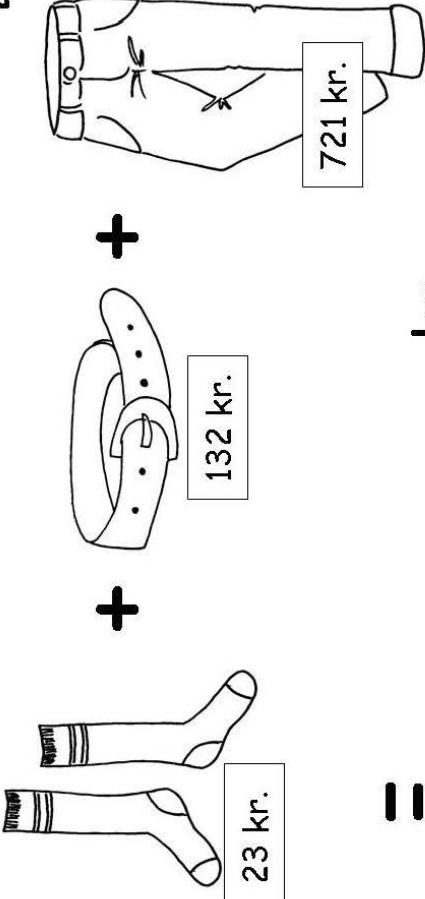

23 kr. + 132 kr. + 721 kr. = \_\_\_\_\_ kr.

Hvad koster sættet?

21

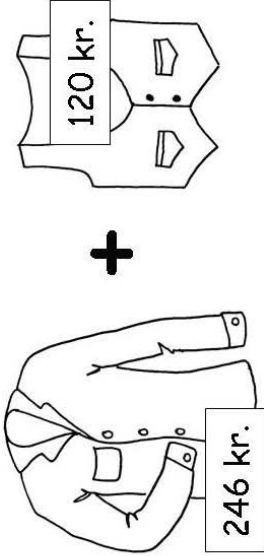

246 kr.

+

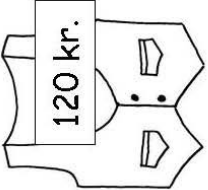

120 kr.

+



300 kr.

= \_\_\_\_\_ kr.

Hvad koster sættet?

23

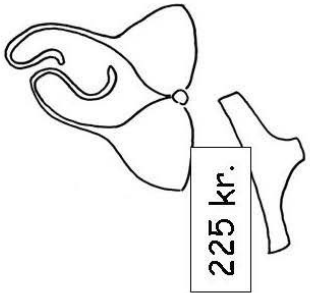

225 kr.

+

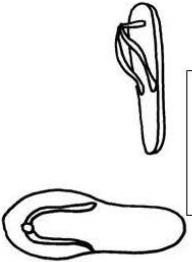

34 kr.

= \_\_\_\_\_ kr.

Hvad koster sættet?

22

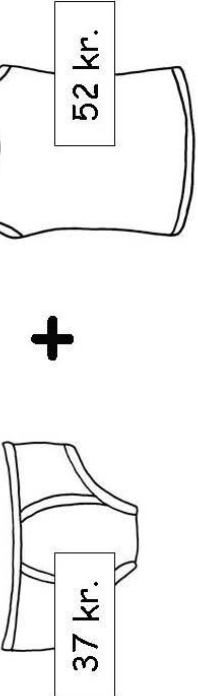

37 kr.

+

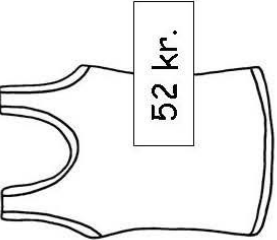

52 kr.

= \_\_\_\_\_ kr.

Hvad koster sættet?

24

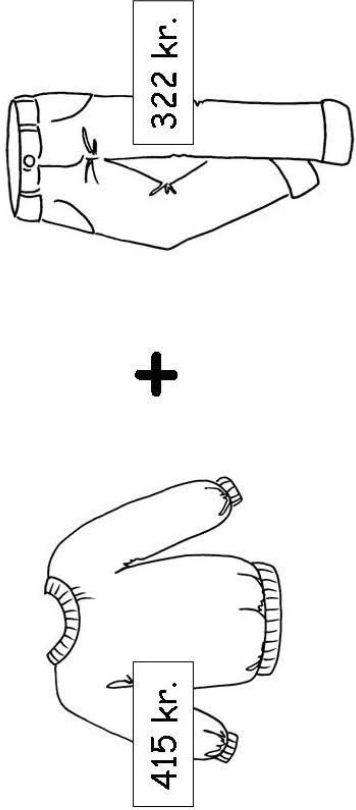

415 kr.

+

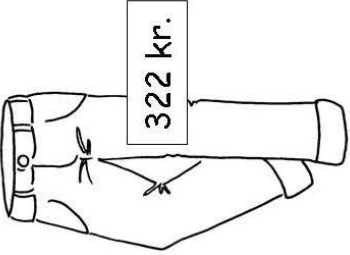

322 kr.

= \_\_\_\_\_ kr.

Hvad koster sættet?

25

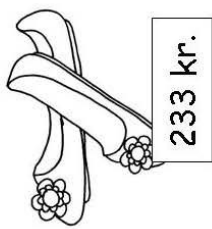

+

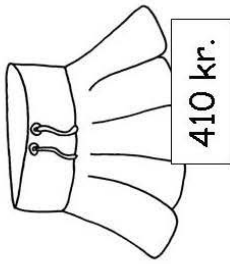

+

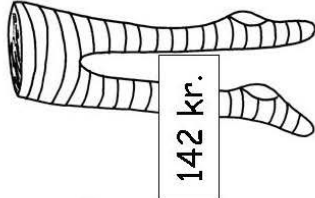

= \_\_\_\_\_ kr.

Hvad koster sættet?

27

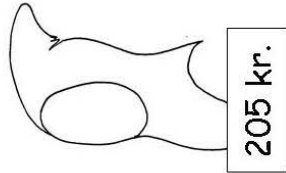

+

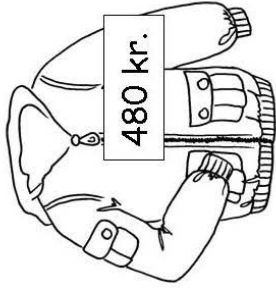

+

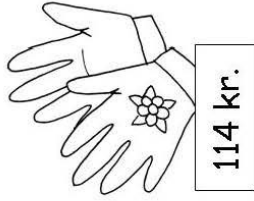

= \_\_\_\_\_ kr.

26

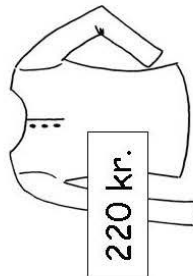

+

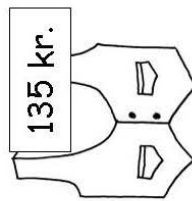

+

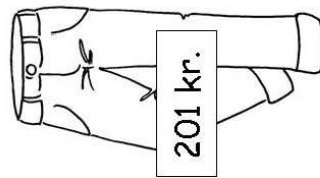

= \_\_\_\_\_ kr.

28

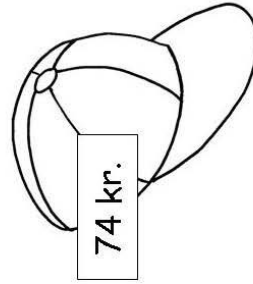

+

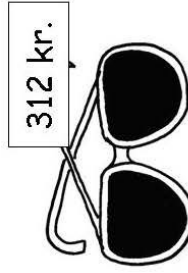

= \_\_\_\_\_ kr.

Hvad koster sættet?

29

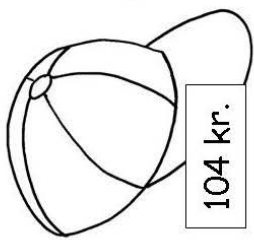

+

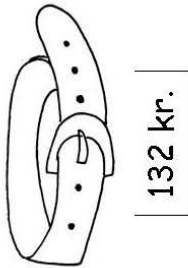

+

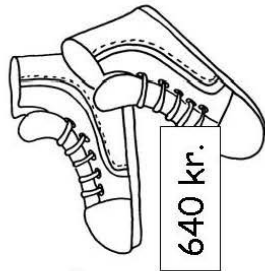

= \_\_\_\_\_ kr.

30

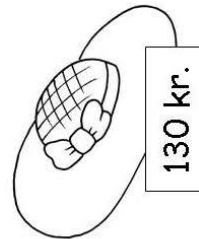

+

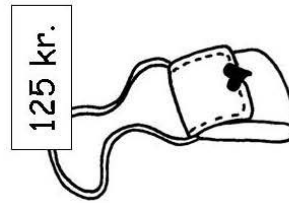

+

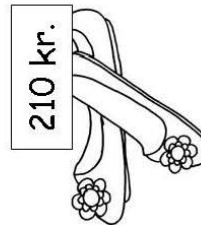

= \_\_\_\_\_ kr.